

PRODUCT CATALOG

ROOF SYSTEMS





IGM MLADOST LEADER IN THE REGION

Mladost is one of the largest and most important manufacturers of construction materials in the region of the Balkans and Southeast Europe with a tradition of over 115 years.

A well-known name on the market, synonymous with quality tiles and blocks for masonry and mezzanine constructions, which, in addition to being present on the domestic market, thanks to their quality, have found their way to satisfied users in many markets: Macedonia, Bulgaria, Romania, Albania, Bosnia and Herzegovina, Slovakia, Montenegro, Russia, Poland, Germany, France and Belgium.



MODERN PRODUCTION

MLADOST owns five production facilities; two plants in Leskovac, Stalac, Mala Plana and Vlasotinac. With large investments, the most modern equipment and technology were introduced in all factories, which, together with extremely high-quality raw materials and professional workforce, enable production that meets the strictest requirements for high-quality, economical and simple construction.

- 115 years of tradition
- Number 1 in the region for the production of clay products
- More than 650 employees
- 50 year warranty

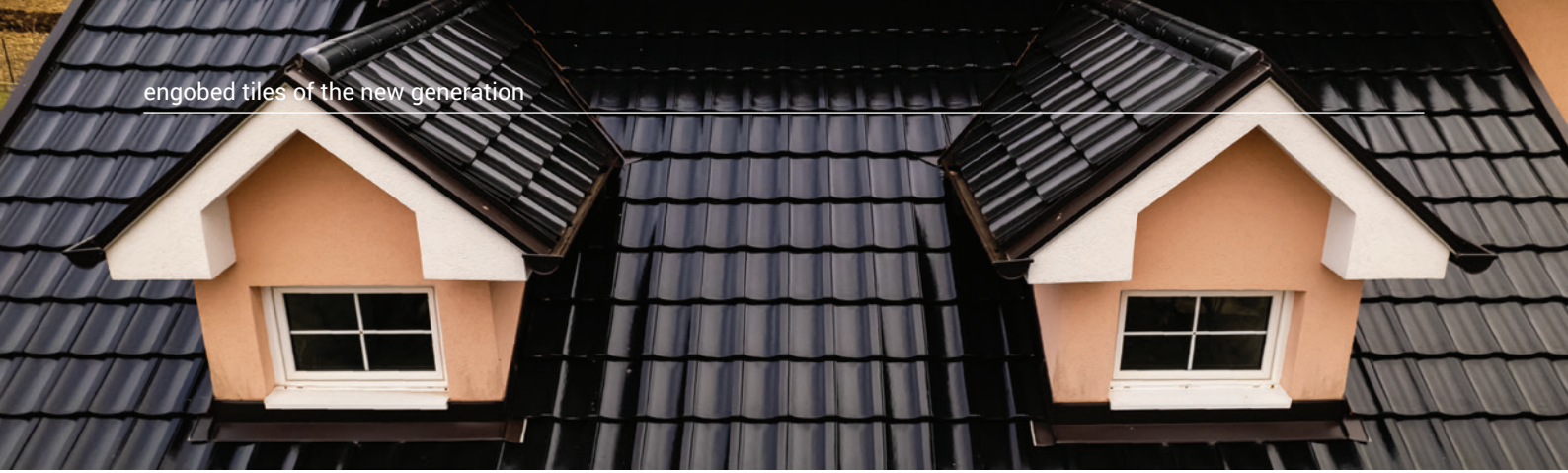

ENGOBORED TILES NEW GENERATIONS

Mladost PRO tile is a premium tile large format, whose surface is ennobled with engobe of different colors (black, brown and red).

Engobed roof tiles with deep double with fakes they fill the complete tightness of the roof surface.

It was produced in a new facility with the most modern technology. Pressed in plaster molds that gives him perfectly sharp and elegant lines.

Made of high quality clay with 50-year durability guarantee.

MLADOST recommends the use of special elements made of ceramics. It results system called "Mladost roof system construction". A system that is invincible in its form and function, which opposes all environmental influences and shows no material wear and tear even after decades of exposure to atmospheric influences. We provide you with special elements separately adapted to the roof tile model in all available colors in matte and gloss surfaces.

SMARTLY DESIGNED IN EVERY DETAIL

Special elements are needed for almost everything functional and detailed areas of the roof surface. In addition to the system of fixing accessories, there are accessories for the edge zones of the roof at the ridge and at the side end. Systems for hanging tiles and systems for protection against snow are made of other materials.

ADVANTAGES YOUTH OF THE ROOF SYSTEM

- The entire system of elements of ceramic and non-ceramic for a complete roof system
- Special elements specially designed for the model roof tiles by shape and color
- Extremely wear-resistant for an extremely long life duration
- Perfect geometry for excellent technical properties
Large format 10 pcs/m² for simple and quick installation
- Production to order for individual construction projects
- Additional non-ceramic equipment for special functional areas

It is pressed with plaster the molds he gives him perfectly sharp and elegant lines.



SPECIAL ELEMENTS

Made of clay.

For perfect roofs.

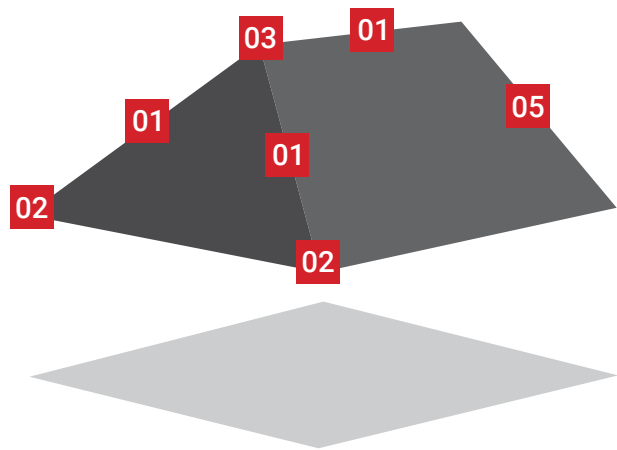

YOUTH ROOF SYSTEM

Just a complete ceramic roof, from eaves to ridge, guarantees an unmistakable total the performance of MLADOST ceramic tiles. An invincible whole in form and function which resists all the influences of the atmosphere and no shows material wear and tear even after several decades. Mladost PRO tile available in three colors in matte and gloss finish.

SPECIAL ELEMENTS

Rounded system The youth of the roof system they also consist of special roof elements; as they are ridges, initial ridges, three-pronged ridges, final elements, snow guards, ventilation tiles that are available in the color of roof tiles.

ROOF EQUIPMENT



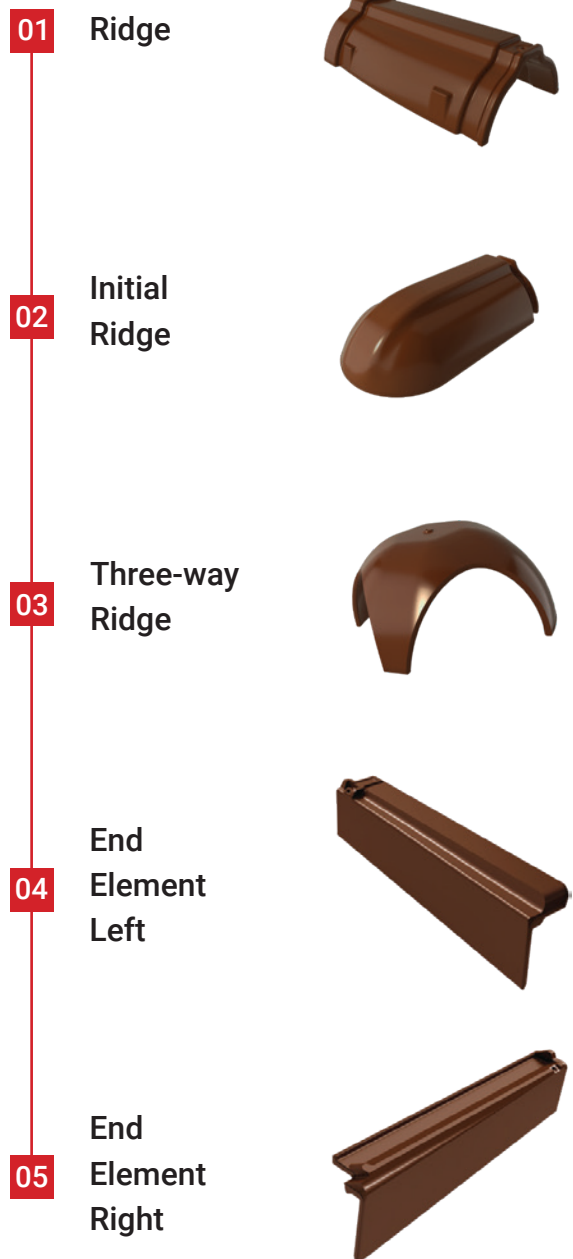

Mladost also provides a complete roof the equipment you need for Youth roof system: ridge ridge strips, clips for the ridge, ridge ridge batten holders, nets for birds, roof foil, etc.





CONTINENT PRO 10[®]

DYNAMIC, ELEGANT, MODERN LINES

-  **Design:** a blend of contemporary and modern design
-  **Surface effect:** straight lines that give eternal elegance
-  **Technology:** the latest technology and the highest quality Engob, Kontinent PRO 10 tile provides a sense of security and durability for future generations
-  **Application:** it can be applied to all types of roofs with a slope of 15 to 45 degrees
-  **Warranty:** 50 years



MLADOST CONTINENT PRO 10 / BLACK / GLOSS



MLADOST CONTINENT PRO 10 / BLACK / MAT

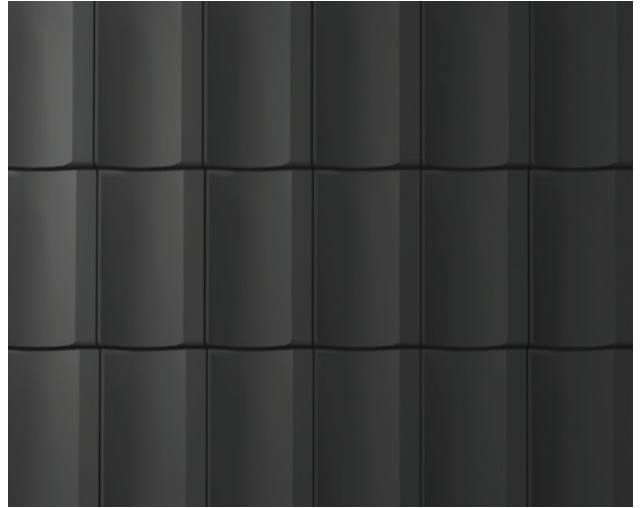

MLADOST CONTINENT PRO 10 / BROWN / GLOSS



MLADOST CONTINENT PRO 10 / BROWN / MAT



MLADOST CONTINENT PRO 10 / RED / GLOSS



MLADOST CONTINENT PRO 10 / RED / MAT

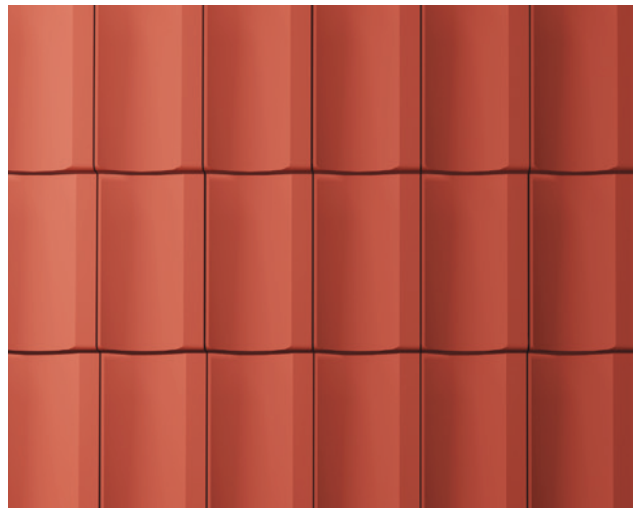

MLADOST CONTINENT PRO 10

GLOSS



MAT



MLADOST

CONTINENT PRO 10



Kontinent PRO 10 is a premium model of large-format tiles, produced in a new plant with the most modern technology. It is pressed with plaster molds, which gives it perfectly sharp lines. Considering that each tile is fired separately in "H - cassettes" at over 1030°C, it is characterized by perfect geometry and excellent technical properties. Thanks to these characteristics, it fits and closes perfectly roof surface. It is produced in black, brown and red colors, each of which has two variants of reflection: matte and shine. It is characterized by sliding installation, which "adjusts" to different, already installed roofs constructions (spaces of slats on the roof).



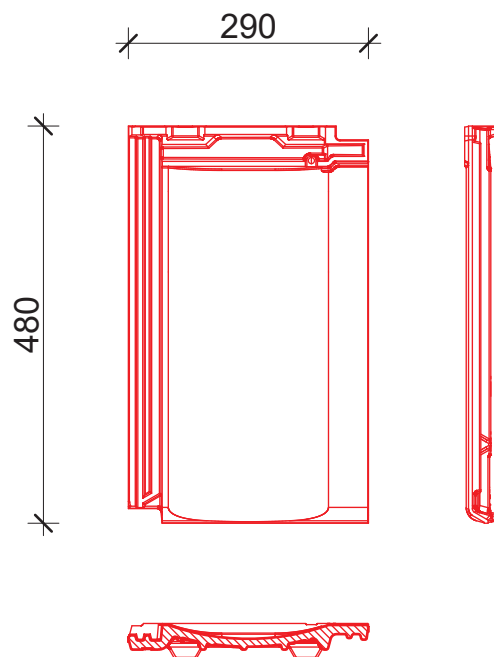

-  Mass: 3.85 kg
-  Length: 480 mm
-  Width: 290 mm
-  Cover length: 40.7 cm
-  Coverage: 25 cm
-  Consumption per m²: 10 pcs
-  Number on pallet: 280 pcs
-  Pallet weight: 1.120 - 1.140 kg
-  Minimum roof pitch: 15° (**vidi stranu 33*)
-  Spacing of slats: 36.5 - 40.5 cm





TRADICIONAL PRO 10[®]

COMBINATION OF TRADITION AND MODERN TECHNOLOGY

-  **Design:** traditional look in step with new manufacturing technology
-  **Surface effect:** classic and simple for all generations
-  **Technology:** the latest technology and the highest quality Engob, Traditional PRO 10 tiles provide a sense of security and durability for future generations
-  **Application:** it can be applied to all types of roofs with a slope of 15 to 45 degrees
-  **Warranty:** 50 years



MLADOST TRADICIONAL PRO 10 / BLACK / GLOSS



MLADOST TRADICIONAL PRO 10 / BLACK / MAT



MLADOST TRADICIONAL PRO 10 / BROWN / GLOSS



MLADOST TRADICIONAL PRO 10 / BROWN / MAT

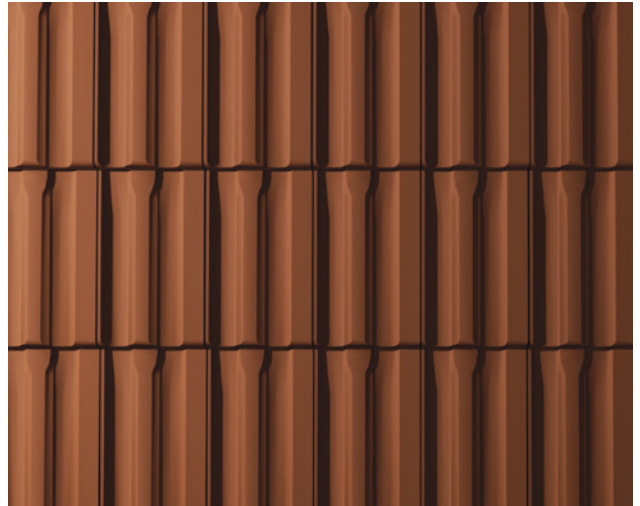

MLADOST TRADICIONAL PRO 10 / RED / GLOSS



MLADOST TRADICIONAL PRO 10 / RED / MAT

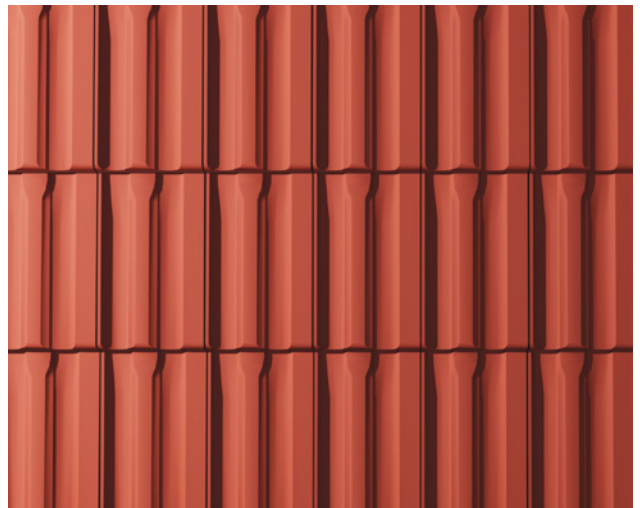

MLADOST TRADICIONAL PRO 10

GLOSS



MAT



MLADOST**TRADICIONAL PRO 10**

Tradicional PRO 10 is a premium model of large-format tiles, which is produced in a new plant with the most modern production technology. Thanks to the plaster molds in which it was pressed it is characterized by an exceptional finish. Each tile is fired separately in "H - cassettes" at over 1030°C, so it is characterized by perfect geometry and excellent technical properties. Thanks to these features, as well as other tiles of the PRO series, fits perfectly and closes the roof surface. It is produced in black, brown and red colors, each of which has two variants of reflection: matte and gloss. It is characterized by a sliding installation, which "adjusts" to different, already installed roof structures (slat spacing on the roof).



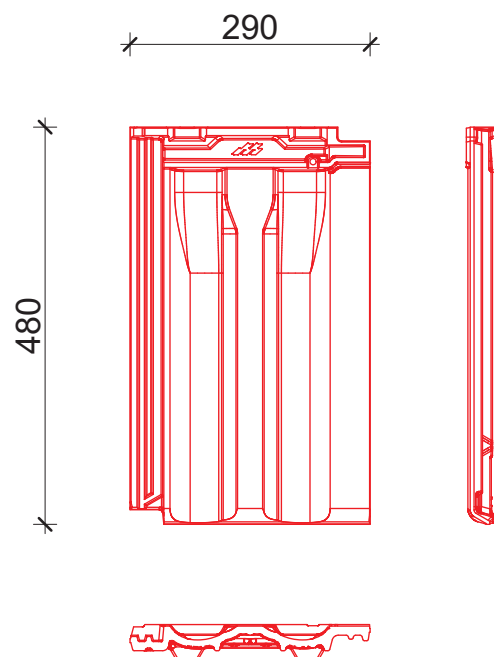

-  Mass: 3.85 kg
-  Length: 480 mm
-  Width: 290 mm
-  Cover length: 40.7 cm
-  Coverage: 25 cm
-  Consumption per m²: 10 pcs
-  Number on pallet: 280 pcs
-  Pallet weight: 1.120 - 1.140 kg
-  Minimum roof pitch: 15° (*vidi stranu 33)
-  Spacing of slats: 36.5 - 40.5 cm





HORIZONT PRO 10[®]

REFINED SIMPLICITY OF ROUNDED LINES

-  **Design:** rounded lines that provide unique elegance
-  **Surface effect:** its elegance emphasizes the individual shape of each roof surface
-  **Technology:** the latest technology and the highest quality Engob, Horizont PRO 10 tile provides a sense of security and durability for future generations
-  **Application:** it can be applied to all types of roofs with a slope of 15 to 45 degrees
-  **Warranty:** 50 years



MLADOST HORIZONT PRO 10 / BLACK / GLOSS

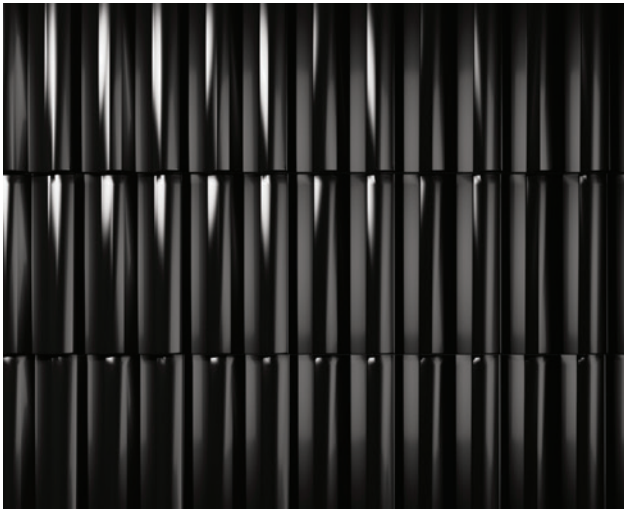

MLADOST HORIZONT PRO 10 / BLACK / MAT



MLADOST HORIZONT PRO 10 / BROWN / GLOSS



MLADOST HORIZONT PRO 10 / BROWN / MAT

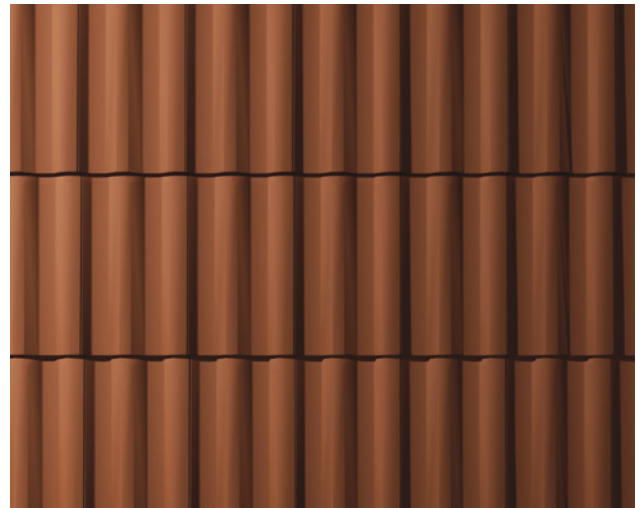

MLADOST HORIZONT PRO 10 / RED / GLOSS

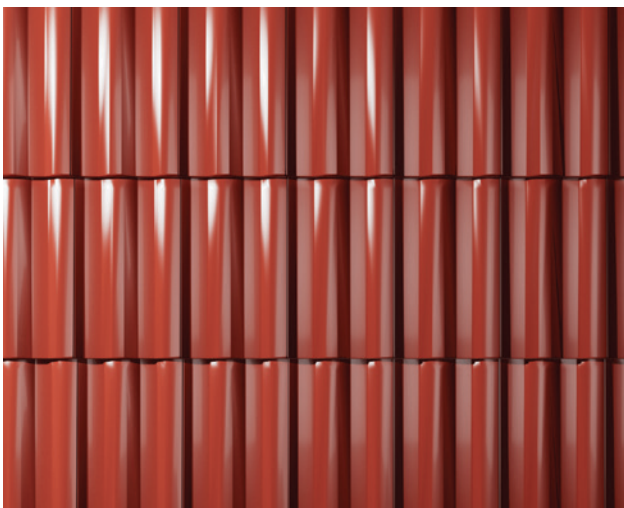

MLADOST HORIZONT PRO 10 / RED / MAT

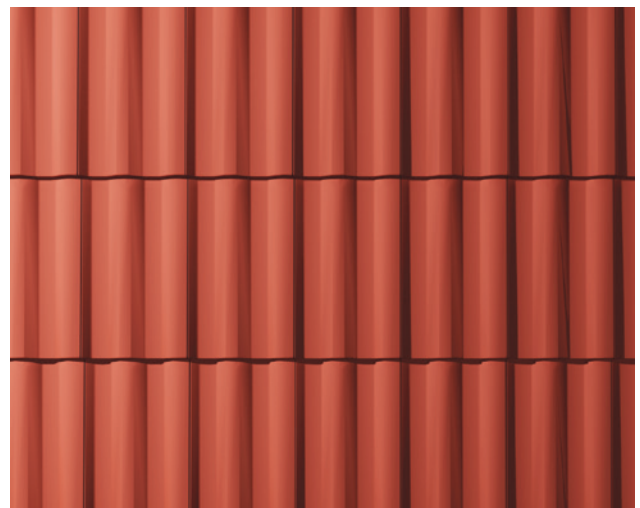

MLADOST HORIZONT PRO 10

GLOSS



MAT

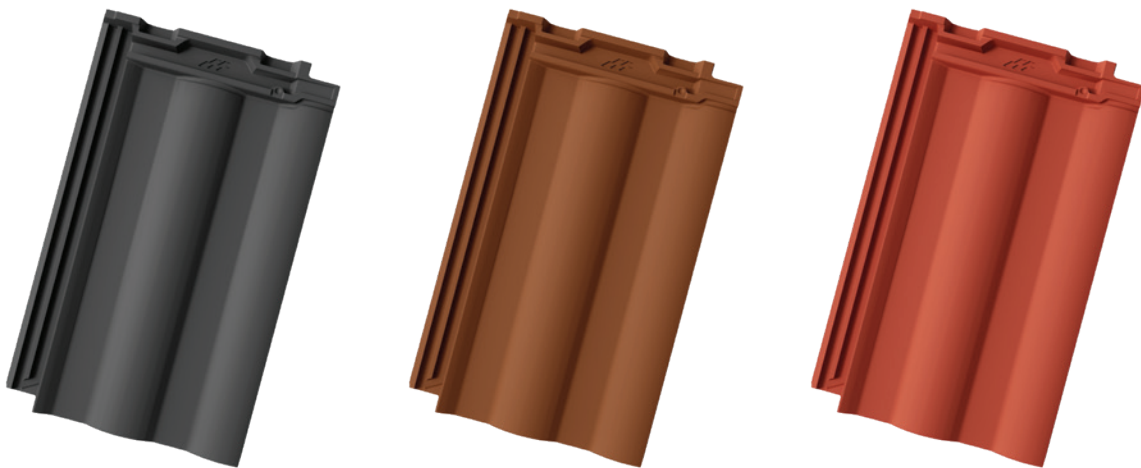

MLADOST

HORIZONT PRO 10



Horizont PRO 10 is a premium model of large-format tiles, produced with the most modern technology in new plant. It is pressed with plaster molds, which gives it perfectly sharp lines. Given that each The tile is fired separately in "H - cassettes" at over 1030°C, it is characterized by perfect geometry, as well as excellent technical properties. Thanks to these characteristics, it perfectly fits and closes the roof surface. It is produced in black, brown and red colors, each of which has two variants of reflection: matte and gloss. Like everything MLADOST tile is characterized by its sliding installation, which "adapts" to different, already installed tiles roof constructions (spaces of slats on the roof).



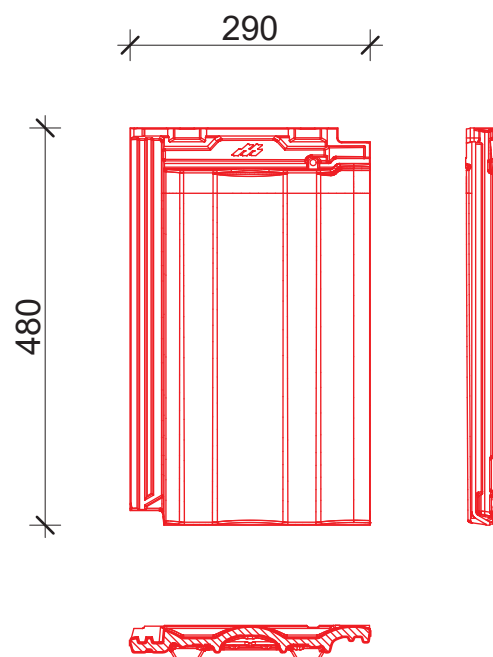

-  Mass: 3.85 kg
-  Length: 480 mm
-  Width: 290 mm
-  Cover length: 40.7 cm
-  Coverage: 25 cm
-  Consumption per m²: 10 pcs
-  Number on pallet: 280 pcs
-  Pallet weight: 1.120 - 1.140 kg
-  Minimum roof pitch: 15° (**vidi stranu 33*)
-  Spacing of slats: 36.5 - 40.5 cm





MAESTRAL PRO 10[®]

MEDITERRANEAN CHARM, SEDUCTORY, DIFFERENT

-  **Design:** a wavy shape that naturally attracts you, already at first glance
-  **Surface effect:** wavy lines that emphasize the individual shape of each roof surface
-  **Technology:** the latest technology and the highest quality Engob, Maestral PRO 10 tiles provide a sense of security and durability for future generations
-  **Application:** deep folds ensure watertightness even on very small roof slopes
-  **Warranty:** 50 years



MLADOST MAESTRAL PRO 10 / BLACK / GLOSS



MLADOST MAESTRAL PRO 10 / BLACK / MAT

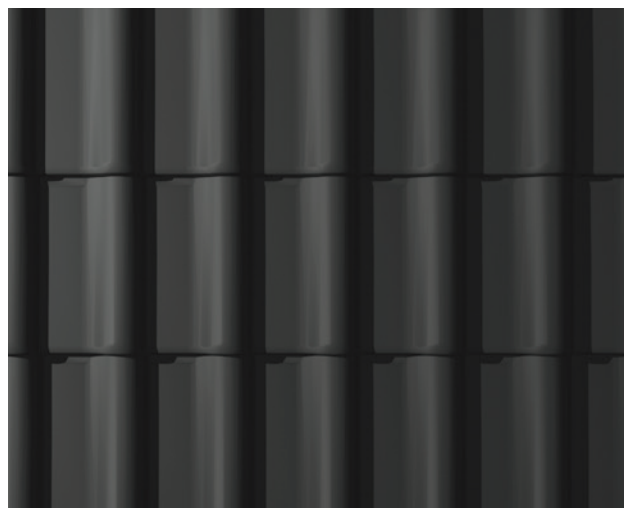

MLADOST MAESTRAL PRO 10 / BROWN / GLOSS



MLADOST MAESTRAL PRO 10 / BROWN / MAT

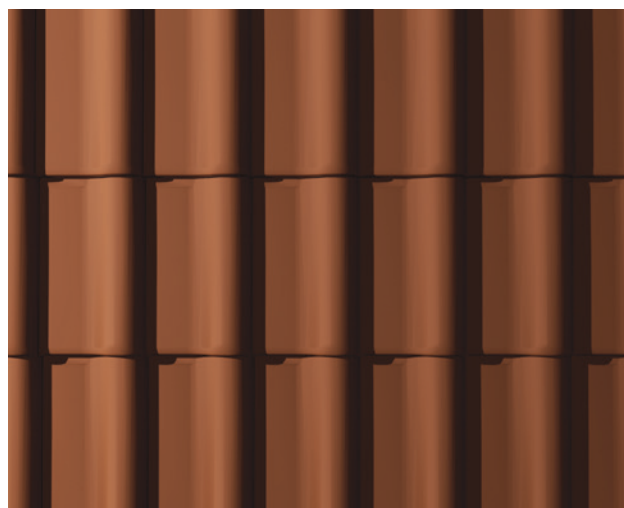

MLADOST MAESTRAL PRO 10 / RED / GLOSS



MLADOST MAESTRAL PRO 10 / RED / MAT



MLADOST MAESTRAL PRO 10

GLOSS



MAT



MLADOST

MAESTRAL PRO 10



Maestral PRO 10 is a new product, created in a new plant with the most modern production technology. The plaster molds in which it is pressed give it an exceptional finish. Each tile is fired separately in "H - cassettes" at over 1030°C, it is characterized by perfect lines and geometry, as well as excellent technical properties. Thanks to these characteristics, like other tiles of the PRO series, it perfectly fits and closes the roof surface. It is produced in black, brown and red, each of which has two variants of reflection: matte and gloss.



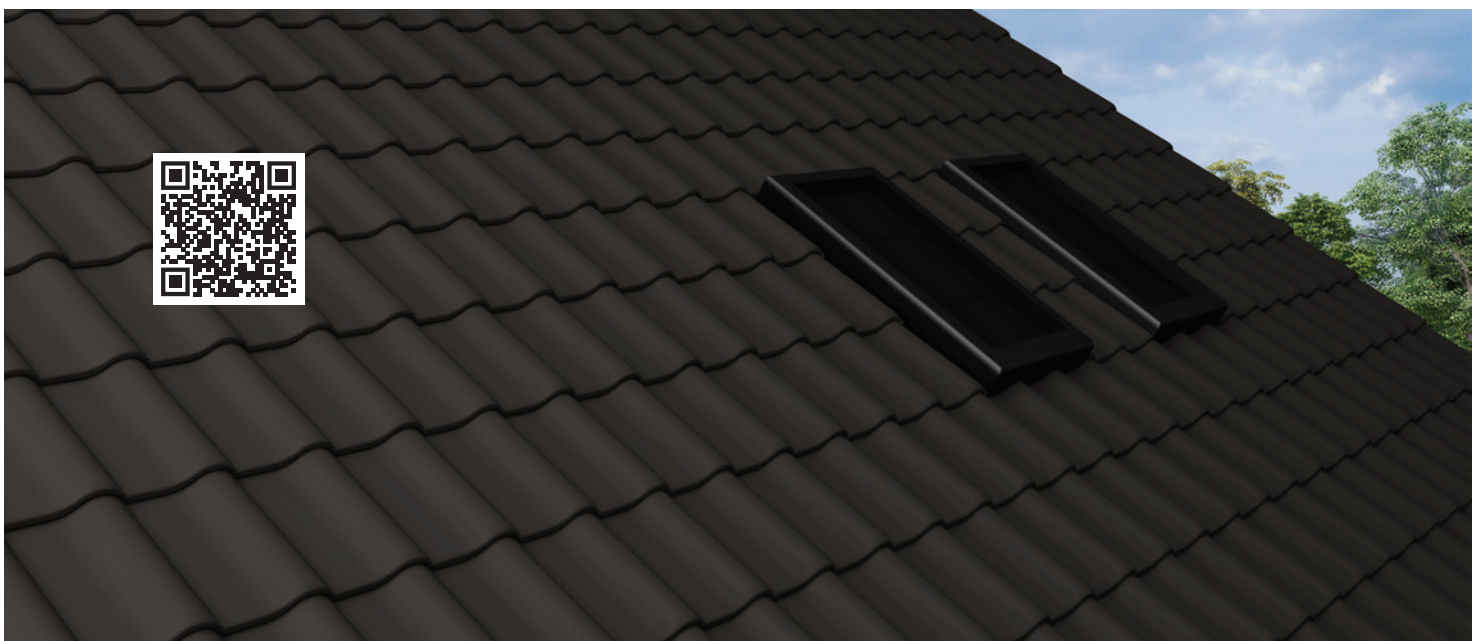
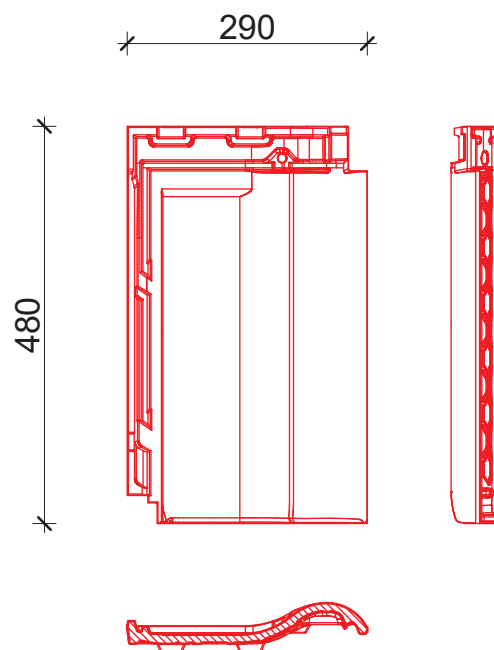

-  Mass: 3.85 kg
-  Length: 480 mm
-  Width: 290 mm
-  Cover length: 40.7 cm
-  Coverage: 25 cm
-  Consumption per m²: 10 pcs
-  Number on pallet: 280 pcs
-  Pallet weight: 1.120 - 1.140 kg
-  Minimum roof pitch: 15° (**vidi stranu 33*)
-  Spacing of slats: 36.5 - 40.5 cm





FUTURA PRO[®]

MODERN TECHNOLOGY FOR MODERN ARCHITECTURE

-  **Design:** A flat and precise shape that creates clean roof lines and fits perfectly into contemporary architectural concepts, as well as classic architecture that values simplicity
-  **Surface effect:** An elegant and flat surface that gives the roof a modern, minimalist appearance and a strong visual identity
-  **Technology:** Manufactured using the latest technology and the highest-quality engobe, the FUTURA PRO tile provides outstanding resistance, durability, and long-term roof stability
-  **Application:** Thanks to its precise interlocking system, it enables safe installation and reliable roof protection in various climatic conditions
-  **Warranty:** 50 years



MLADOST FUTURA PRO



Available in colors:

mat



black anthracite brown



MLADOST FUTURA PRO





- ELEGANT
- SOPHISTICATED
- INSPIRATIONAL
- CONTEMPORARY



MLADOST FUTURA PRO



Futura PRO is a tile with straight and elegant lines that fully follows the style of the 21st century. Its clear structure and modern design combined with the most modern production technology and the use of the highest quality engobe responds to the requirements of modern architecture.

-  Mass: 3.80 kg
-  Length: 455 mm
-  Width: 274 mm
-  Cover length: 39.3 cm
-  Coverage: 23.5 cm
-  Consumption per m²: 10.8 pcs
-  Number on pallet: 280 pcs
-  Pallet weight: 1.120 - 1.140 kg
-  Minimum roof pitch: 15°
-  Spacing of slats: 36 - 38 cm

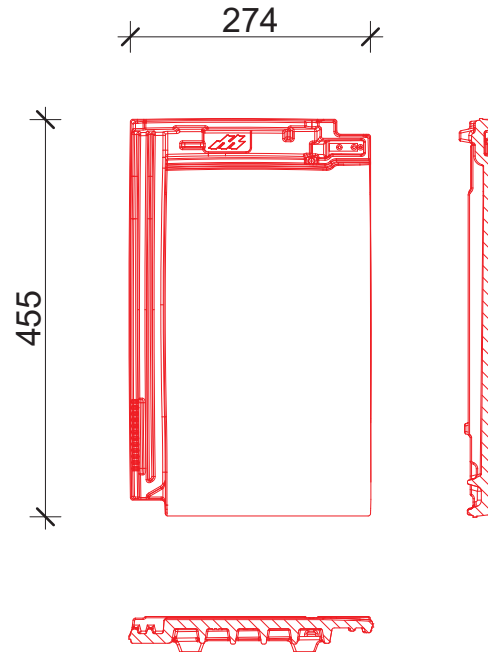

POSSIBILITY OF MATCHING :

Stacking in rows:

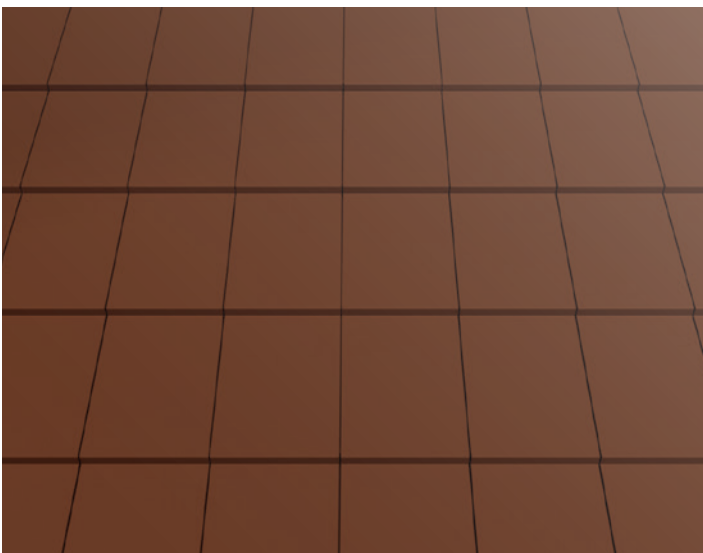



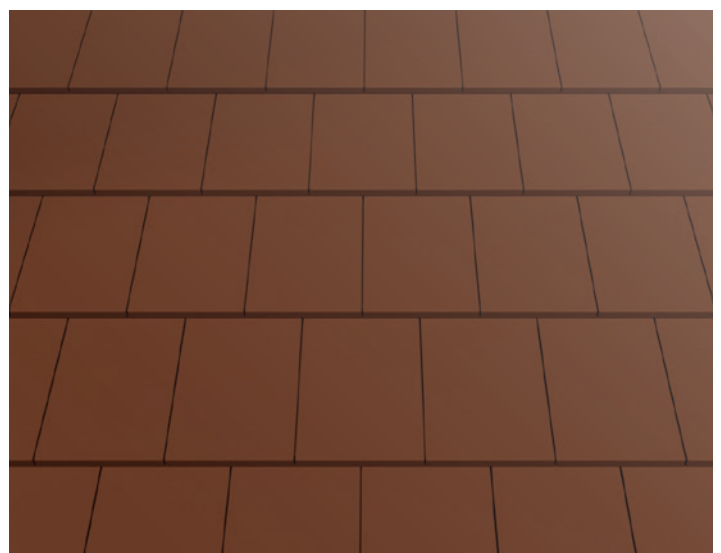

Stacking by overlapping:





CONTINENT NATUR PRO 12[®]

DYNAMIC, ELEGANT, MODERN LINES

-  **Design:** a blend of contemporary and modern design
-  **Surface effect:** straight lines that give eternal elegance
-  **Technology:** produced with the latest technology in gypsum molds in which it is pressed, it is characterized by an exceptional finish that provides a sense of security and durability for future generations
-  **Application:** it can be applied to all types of roofs with a slope of 15 to 45 degrees
-  **Warranty:** 50 years



MLADOST

KONTINENT NATUR PRO 12



Kontinent Natur PRO 12 is an improved version of Kontinent ECO tiles. It represents a premium tile model which is produced in a new plant with the most modern production technology in plaster molds. A combination of the traditional part of the use of decades proven best quality ceramic clays for making rough ceramics and modern architectural product design.

It gives the vision of a flat roof with an aesthetic effect of light refraction in a slightly concave surface. Made of high-quality clay with a 50-year durability guarantee.

-  Mass: 3.1 kg
-  Length: 415 mm
-  Width: 260 mm
-  Cover length: 36.7 cm
-  Coverage: 22.6 cm
-  Consumption per m²: 12 pcs
-  Number on pallet: 320 pcs
-  Pallet weight: 1.025 - 1.040 kg
-  15° Minimum roof pitch: 15° (**vidi stranu 33*)
-  Spacing of slats: 33.5 - 36.5 cm

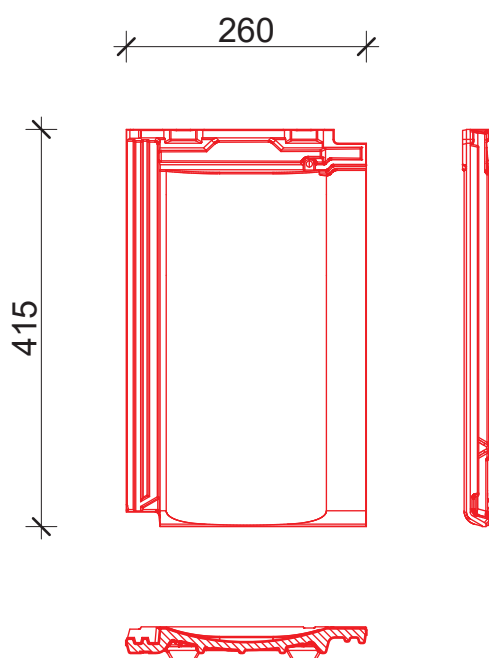



TRADICIONAL NATUR PRO 12[®]

COMBINATION OF TRADITION AND MODERN TECHNOLOGY

-  **Design:** traditional look in step with new manufacturing technology
-  **Surface effect:** classic and simple for all generations
-  **Technology:** produced with the latest technology in gypsum molds in which it is pressed, it is characterized by an exceptional finish that provides a sense of security and durability for future generations
-  **Application:** it can be applied to all types of roofs with a slope of 15 to 45 degrees
-  **Warranty:** 50 years



MLADOST

TRADICIONAL NATUR PRO 12



Tradicional Natur PRO 12 is an improved version of Tradicional ECO tiles. It represents a premium tile model which is produced in a new plant with the most modern production technology in plaster molds.

The tile has an aesthetically traditional shape, with double ridges and double channels on the upper surface which provides high mechanical resistance and security against weather conditions. Made of high quality clay with a durability guarantee of 50 years.

-  Mass: 3.1 kg
-  Length: 415 mm
-  Width: 260 mm
-  Cover length: 36.7 cm
-  Coverage: 22.6 cm
-  Consumption per m²: 12 pcs
-  Number on pallet: 320 pcs
-  Pallet weight: 1.025 - 1.040 kg
-  Minimum roof pitch: 15° (**vidi stranu 33*)
-  Spacing of slats: 33.5 - 36.5 cm

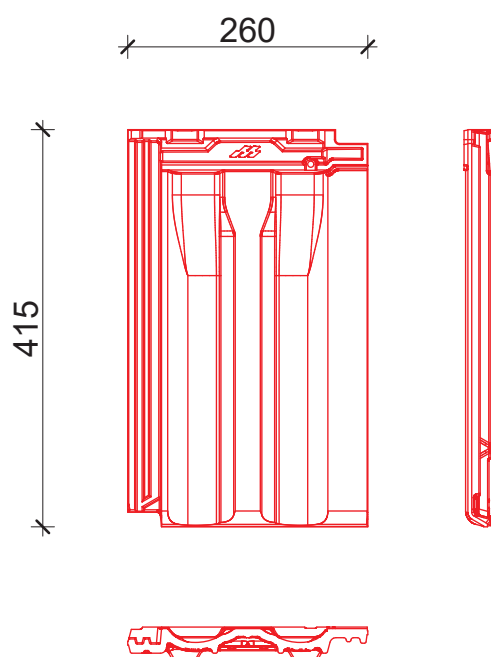

MLADOST

SPECIAL ELEMENTS PRO 10

MLADOST Ventilation tile PRO 10

GLOSS



MAT

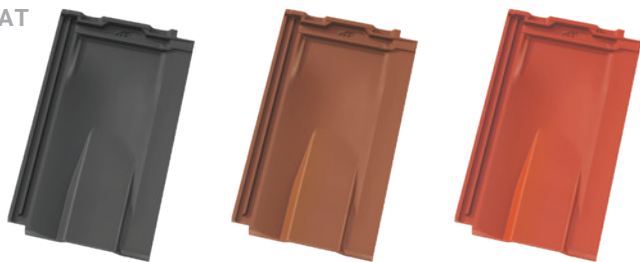

It is intended for efficient ventilation of the roof, thus eliminating the possibility of condensation and moisture collection. By refining the above surfaces with engobo we get special ones elements of beautiful and stable colors in gloss and matte variants. Proven service life of roof tiles and of special elements is over 50 years. Adapts to all MLADOST models PRO 10 tiles and because of that the roof will look visually as one beautiful and harmonious whole.

Method of application:
Depending on the climatic and technical conditions, the slope of the roof is projected, from 15° to 22°.

Mass: 4.10 kg
Length: 480 mm
Width: 290 mm
Cover length: 40.7 cm
Coverage: 25 cm
Consumption per m²: 10 pcs
Minimum roof pitch: 15°
Number on pallet: 140 pcs
Pallet weight: 610 kg

MLADOST Starting ridge PRO 10

A special element in the roof system that connects form and functionality, achieving the best protection in extreme weather conditions.

Mass: 3.18 kg
Length: 390 mm
Width: 205 mm
Number on pallet: 32 pcs
Pallet weight: 120 kg



MLADOST Ridge PRO 10

A special element that, together with the roof coverings, makes the roof construction unique and long-lasting. With its unique design in combination with PRO quality tiles, it provides an aesthetic roof surface uniformity and absolute functionality.



Mass: 3.42 kg
 Length: 385 mm
 Width: 210 mm
 Consumption (kom/m): 2.8 pcs
 Number on pallet: 160 pcs
 Pallet weight: 575 kg

MLADOST Three-way ridge PRO 10

A special element that, together with the roof coverings, makes the roof construction unique and long-lasting. With its unique design in combination with PRO quality tiles, it provides an aesthetic roof surface uniformity and absolute functionality.



Mass: 3.14 kg
 Number on pallet: 24 pcs
 Pallet weight: 110 kg

MLADOST End element - left and right PRO 10

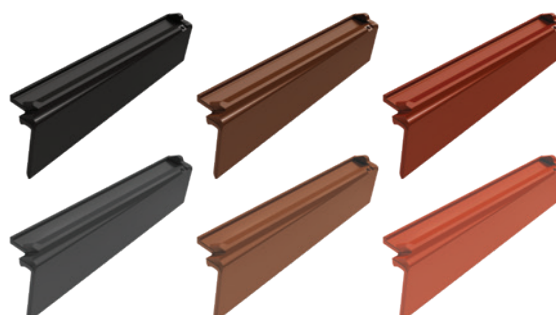
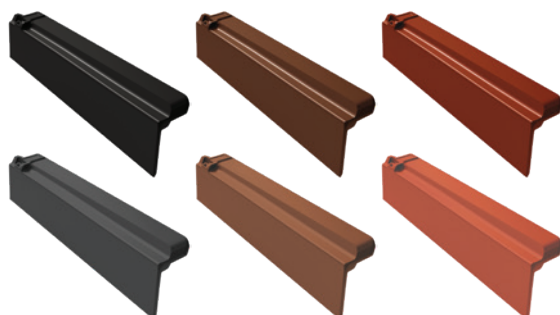

Shaped element used in the roof system instead of wind moldings, and with roof tiles and the rest accompanying elements make a unique roof the whole.

Mass: 2.50 kg; Length: 480 mm
 Consumption (kom/m): 2.5 pcs
 Number on pallet: 84 pcs
 Pallet weight: 235 kg

MLADOST

SPECIAL ELEMENTS FUTURA PRO

MLADOST

Ventilation tile FUTURA PRO

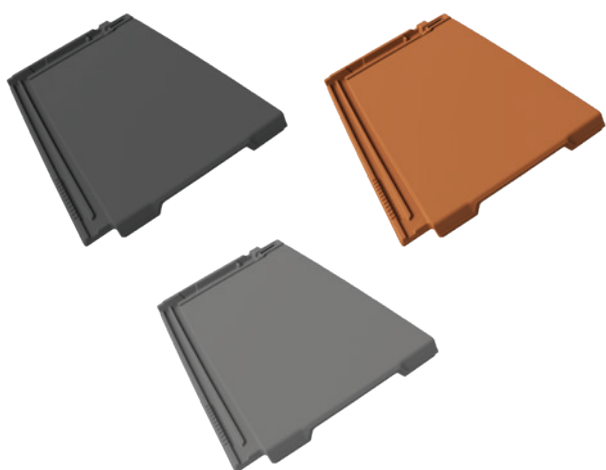

It is intended for efficient ventilation of the roof, thus eliminating the possibility of condensation and moisture collection. By refining the above surfaces with engobo we get special ones elements of beautiful and stable colors in gloss and matte variants. Proven service life of roof tiles and of special elements is over 50 years. Adapts to all MLADOST models PRO 10 tiles and because of that the roof will look visually as one beautiful and harmonious whole.

Method of application:

Depending on the climatic and technical conditions, the slope of the roof is projected, from 15° to 22°.

Mass: 4.10 kg
 Length: 480 mm
 Width: 290 mm
 Cover length: 40.7 cm
 Coverage: 25 cm
 Consumption per m²: 10 pcs
 Minimum roof pitch: 15°
 Number on pallet: 140 pcs
 Pallet weight: 610 kg

MLADOST

Half-tile FUTURA PRO

The half-tile model for FUTURA PRO is placed so that the joints of the tiles do not match, but instead they move by one half of the tile width. Matching rows of tiles in the end of the eaves is achieved by placing semi-tiles.

Mass: 2 kg
 Length: 455 mm
 Width: 155 mm

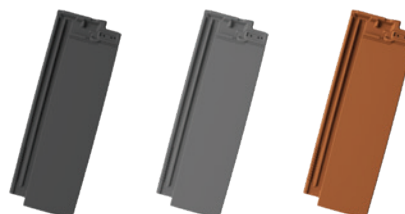

MLADOST

Starter gutter FUTURA PRO

A special element in the roof system that connects form and functionality, achieving the best protection in extreme weather conditions.

Mass: 3 kg
 Length: 375 mm
 Width: 225 mm
 Number on pallet: 32 pcs
 Pallet weight: 125 kg



MLADOST

Gutter FUTURA PRO

A special element that, together with the roof coverings, makes the roof construction unique and long-lasting. With its unique design in combination with PRO quality tiles, it provides an aesthetic roof surface uniformity and absolute functionality.

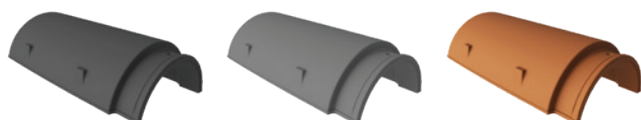

Mass: 3.42 kg
 Length: 385 mm
 Width: 210 mm
 Consumption (kom/m): 2.8 pcs
 Number on pallet: 160 pcs
 Pallet weight: 575 kg

MLADOST

Three-way ridge FUTURA PRO

A special element that connects the roof constructions of differently designed roofs, with its unique the design in combination with the PRO quality tiles ensures the aesthetic uniformity of the roof surface and absolute functionality.

Mass: 3.75 kg
 Number on pallet: 25 pcs
 Pallet weight: 115 kg



MLADOST

End element - left and right FUTURA PRO



Shaped element used in the roof system instead of wind moldings, and with roof tiles and the rest accompanying elements make a unique roof the whole.

Mass: 2.35, 2.36 kg; Length: 470, 455 mm
 Consumption (kom/m): 2.6 kom
 Number on pallet: 84 pcs
 Pallet weight: 230 kg

MLADOST

SPECIAL ELEMENTS NATUR PRO 12

MLADOST Ventilation tile NATUR PRO 12



Ventilation tiles are used for efficient ventilation of the roof, which is eliminated occurrence of condensation and moisture collection.

They are set:
- for air intake
in the second row from the bottom
(from the eaves)
- for air outlet

Weight: 3.24 kg
Length: 415 mm
Width: 260 mm
Cover length: 36 cm
Cover width: 22 cm
Minimum roof slope: 15°
Number on the pallet: 168 pcs
Pallet weight: 565 kg

MLADOST Starting ridge NATUR PRO 12

Starting ridge NATUR PRO 12 as special element in the roof system connects form and functionality, which achieves the best protection in the code extreme weather conditions.

Weight: 3.18 kg
Length: 390 mm
Width: 213 mm
Number on the pallet: 32 pcs
Pallet weight: 125 kg



MLADOST

Gutter NATUR PRO 12



The NATUR PRO 12 ridge is deeper special element that with the roof covers make up the roof structure unique and long-lasting.

Weight: 3.3 kg
Length: 390 mm
Width: 215 mm
Consumption (pcs/m): 2.8 pcs
Number on the pallet: 180 pcs
Pallet weight: 635 kg

MLADOST

Three-way ridge NATUR PRO 12



The NATUR PRO 12 three-way ridge is a special element that connects the roofs constructions of differently designed roofs, not only aesthetically but also functionally expresses the continuity of the roof system.

Weight: 3.1 kg
Number on the pallet: 24 pcs
Pallet weight: 95 kg

MLADOST

End element - left and right NATUR PRO 12



The finishing elements of NATUR PRO 12 are fashion pieces that are in the roof system they use instead of wind moldings, and with roof tiles and other accessories elements make a unique roof the whole.

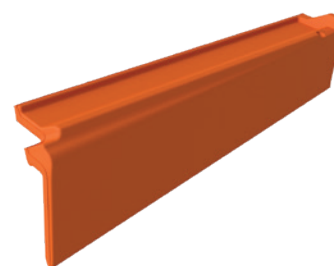

Weight: 2 kg
Length: 415 mm
Number on the pallet: 182 pcs
Pallet weight: 385 kg

Detail of roof eaves covering

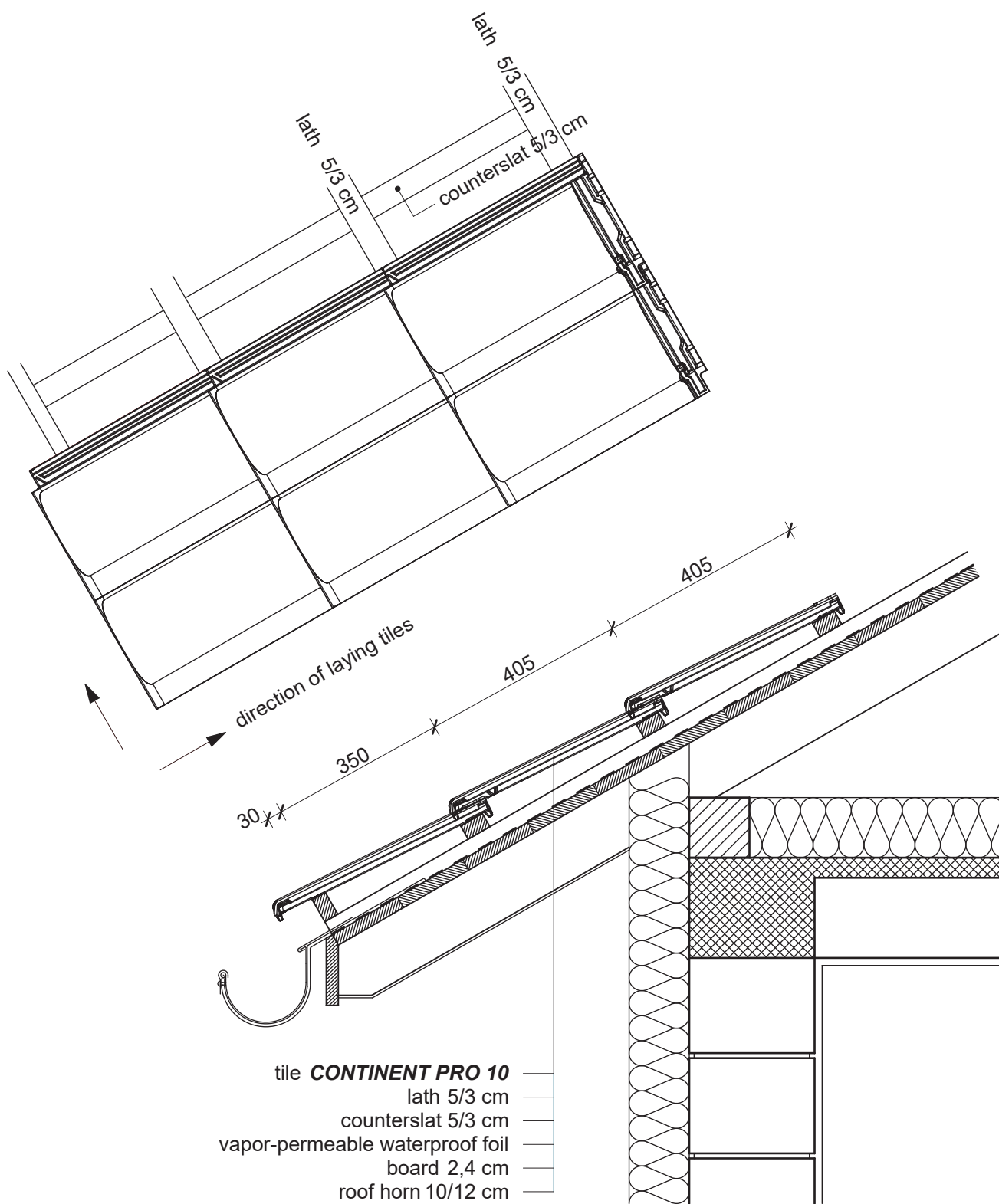

MLADOST

ROOF EQUIPMENT

MLADOST Ridge ridge strip

A universal element for dry construction of ridges and ridges that allows ventilation below ridge. There are self-adhesive fixing strips on the edge on both sides of the ridge strip on the roof tile.

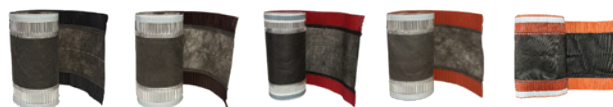

MLADOST Ridge batten holder

Element for fastening ridge ridges slats. By use and proper installation an accurate and straight ridge line is obtained.



MLADOST Bird net

A bird net is used for the lower ones roof vents, prevents entry of birds and insects into the roof construction.



MLADOST Ridge clip PRO and NATUR

A metal element used for fastening ridge tiles in the dry installation process.



MLADOST Ventilation set

The ventilation set will provide functionality and longevity of your roof. Contains rubber ventilation tile, ventilation pipe and ventilation hose. Prevents penetration and damage caused by moisture. It is adaptable to all models of Mladost PRO roof tiles.



MLADOST Metal snow guard PRO and NATUR

Prevents avalanches, intended models Kontinent PRO, Traditional PRO, Horizont PRO, Continent NATUR and Traditional NATUR.



MLADOST Drip comb

It is used as an element that allows ventilation in areas of roof gutters and prevents rodents, birds and large insects to pass under the surface of the roof. By using these elements your roof will be complete functional and safe.



MLADOST Roof foil 150g

Waterproof parapermeable self-adhesives roof foils allow proper drying construction and insulating materials, increase thermal insulation properties, prolong life duration of construction, prevent penetration pest.



MLADOST Home plate

It is used to close gutters near the roofs of two waters.



WARRANTY CERTIFICATE



1. The lifetime of the product is 50 years. IGM MLADOST guarantees that the tiles will be delivered within the specified time period to meet the quality criteria defined by national standards SRPS EN 1304.
2. If the tile within the warranty period does not meet any of the criteria of product characteristics checked by methods: frost resistance - EN 539:2-2013, waterproofness - EN 539:1-2006, deviation from the size indicated in Declaration on performance - EN 1024:2012, which fundamentally affect its functionality, IGM MLADOST undertakes to replace all roof tiles where defects related to the characteristics of the roof tiles have been fixed from the warranty conditions.
3. The customer undertakes to install the tiles according to the **RULE ON TECHNICAL NORMS FOR DESIGN AND EXECUTION OF FINAL WORKS IN CONSTRUCTION**, as well as in the manufacturer's instructions relating to application of the product, and are contained in the manufacturer's prospectus materials.
4. The provision of the guarantee is conditional on cumulative compliance with the following requirements:
 - Before installation, the Customer has the obligation to visually check the products. If the products show defects in appearance or The customer believes that there are differences in relation to the product standard, the products will not be mounted. User has the obligation to report defects to the seller as soon as possible.
 - Compliance with technical specifications and installation instructions (Basic principles for building roofs from ceramic tile) in connection with:
 - Roof structures, in order to enable natural ventilation of the cover,
 - Method of coverage,
 - Ventilation of the entire covering surface,
 - Compliance with minimum mounting slopes.
5. The warranty period starts from the month and year of tile production (the month and year of production are indicated with a permanent mark on the back of the tile).
6. When making a complaint about the quality of the tiles, the Customer undertakes to:
 - Send the complaint in writing to the manufacturer, as well as photo documentation,
 - To state the type of tile, quantity, place of installation, reasons for complaint, date of purchase and type of damage,
 - To attach the purchase receipt and warranty card with the complaint.
7. The warranty does not cover if:
 - Damage caused by mechanical stress and damage caused by natural phenomena with an extraordinary character (eg damage from hail and other weather disasters),
 - Changes in the surface or appearance of the coating, caused by climatic and environmental conditions, microorganisms (including moss formation), efflorescence (salt deposits on the surface of ceramic elements),
 - Differences in color do not represent a lack of quality,
 - Fading, discoloration and signs of rubbing, scratches, which do not affect the water resistance of ceramic tiles,
 - Improper use of roof tiles.
8. The warranty applies to all tiles and ceramic special elements from the MLADOST program.

tile / model:

date of purchase:

name, seat and seal of the company:

customer, address of installation facility:

1911





1911



MLADOST

THE CROWN OF EVERY HOUSE

April 2026.

IGM MLADOST D.O.O. LESKOVAC
16000 Leskovac, Puškinova bb
Tel: +381 (0)16 265 826
Fax: +381(0)16 251 553
Email: prodaja@mladost.co.rs



mladost.co.rs

Engobed tiles of the new generation